

# ***SURFACE WOW***

**WONDER WALLS  
CORK DESIGN ELEMENTS**

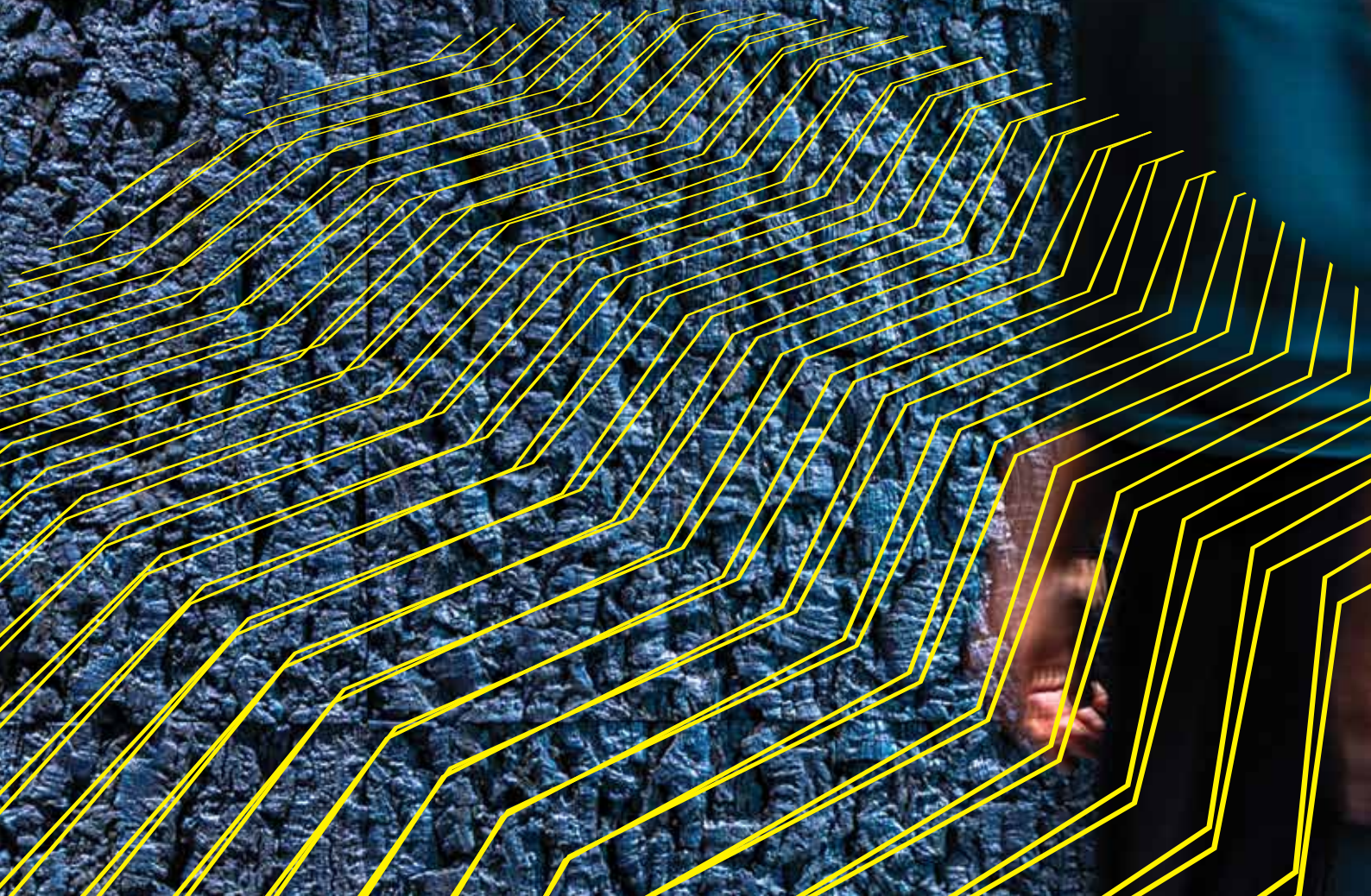

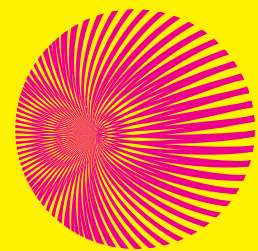

# **SURFACE WOW**

## **CORK DESIGN ELEMENTS**

RUSTICORK / BARK	PAGE 21
RUSTICORK / BLUEMOON	PAGE 25
RUSTICORK / SLATE	PAGE 29
3D FORMS / PYRAMID BLUEMOON	PAGE 33
3D FORMS / PYRAMID NATURAL	PAGE 37
MODULAR BLUEMOON	PAGE 39
TATAMI CORK WALL TILES	PAGE 41
WOW CORKWALL STRIPE	PAGE 43
WOW CORKWALL KITE	PAGE 49
WOW CORKWALL LINE	PAGE 53



**CHOOSE THE WOW  
WALL PRODUCT THAT  
SUITS YOUR STYLE AND  
ENJOY THE AMAZING  
VISUAL IMPRESSION  
EVERY DAY.**



## ***DELIVERING NATURE TO YOUR WALLS.***

WOW WALL Cork design elements are Natural, Sustainable 3D wall panels that are earthy and warm. The natural material is particularly popular due to its low weight and uncomplicated installation on the wall.



Environmentally Friendly



Renewable, Recyclable & Biodegradable



Natural Thermal & Acoustic Isolation

# **SURFACE WOW**

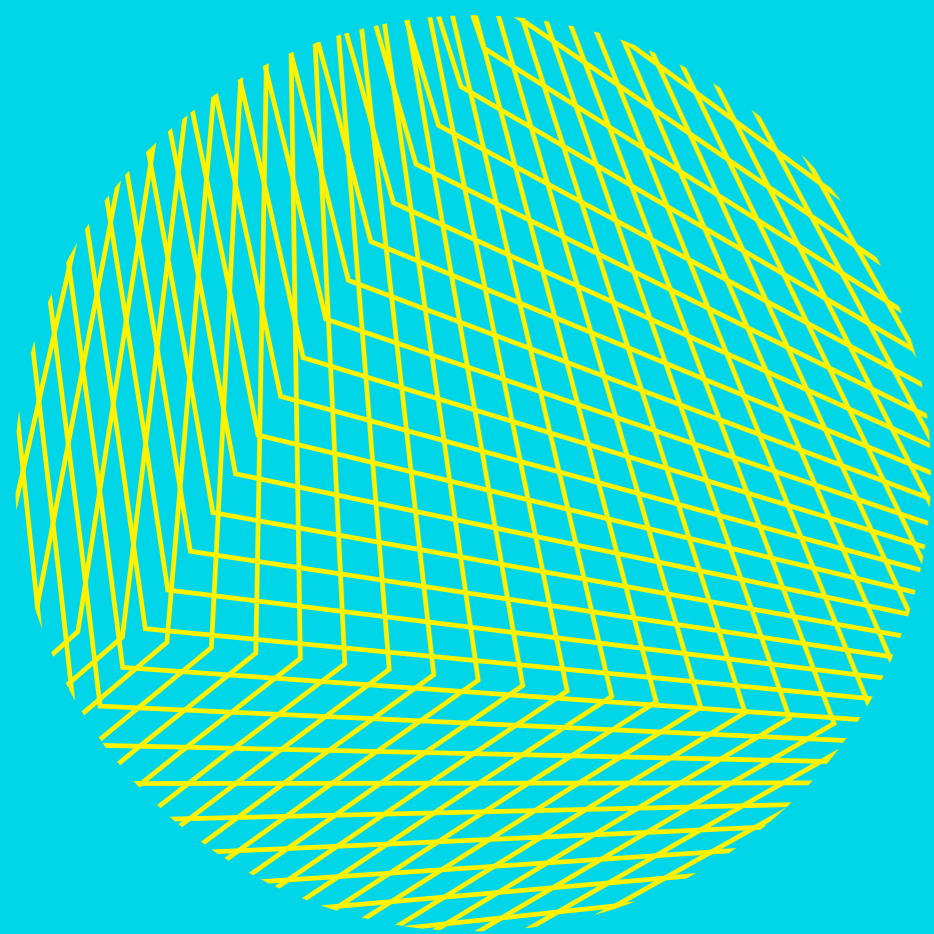

**CREATE UNIQUE SPACES IN A  
SIMPLE AND STYLISH WAY.**



Natural Thermal &  
Acoustic Isolation

# CHOOSE YOUR STYLE.

# A SELECTION OF TEXTURE, COLOR AND DESIGN.

Rusticork  
Bark



Rusticork  
Bark / Bluemoon



Rusticork  
Slate



Tatami Cork Wall  
Tiles / Natural



Modular  
Bluemoon



Wow  
Corkwall  
Stripe



Pyramid  
Natural



Pyramid  
Bluemoon



Wow  
Corkwall  
Line



Wow  
Corkwall  
Kite



Environmentally  
Friendly



Environmentally  
Friendly

# **SURFACE WOW**



**WOW WALL**

## **EASY INSTALLATION**

The natural material cork bark is particularly popular due to its light weight and uncomplicated installation on the wall. At the same time, the cork bark creates a pleasant room climate, providing natural and thermal acoustic insulation.

**BRING YOUR  
BRAND TO  
LIFE WITH EYE  
CATCHING WOW  
WALLS.**

**WOW WALL**



**WOW WALL**

**ADD NATURE TO  
YOUR SPACE WITH  
GREEN SUSTAINABLE  
WALL SOLUTIONS.**



Environmentally  
Friendly



**SURFACE  
WOW**





**CREATE UNIQUE  
SPACES IN A SIMPLE  
AND STYLISH WAY.**



Natural Thermal &  
Acoustic Isolation

**ENJOY THE AMAZING  
VISUAL IMPRESSION  
EVERY DAY.**

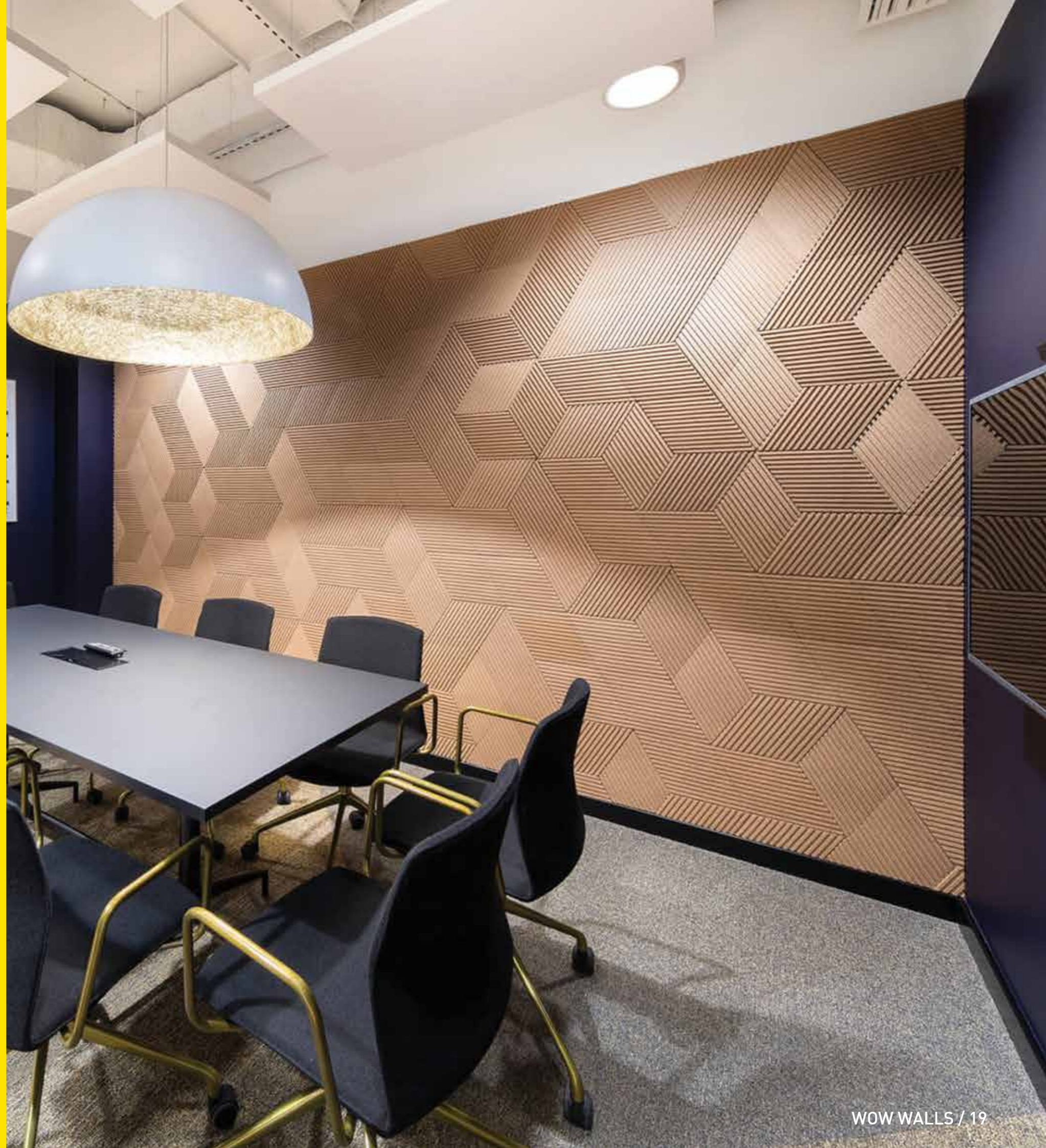



## RUSTICORK / BARK



RUSTICORK tiles and panels create natural, bold, unique and beautiful walls that only cork, obtained directly from the bark of the cork oak tree, can offer. The cork bark is particularly popular due to its low weight and uncomplicated installation on the wall.

### Description

- Glue-on wall installation
- CORKGUARD® finished
- Safe and easy to handle and install
- Increases the thermal comfort
- Reduces airborne noise
- No toxic gases when burning
- No PVC and no softeners or other chemicals hazardous to health or the environment
- Natural, biodegradable and recyclable product

### Material:

Cork, granulated and plain pieces of different sizes, shapes and qualities depending on the design type; Polyurethane cork binder.

**Dimensions:**  
600 x 300 mm

**Thickness:**  
25mm -35mm

**Colours:**  
Natural cork bark

**Design:**  
3D Installation

**Application:**  
Wall design

### Application example:

Anywhere you want to make the interior unique, office walls, hospitality, retail spaces, exhibition stands, reception areas and home.

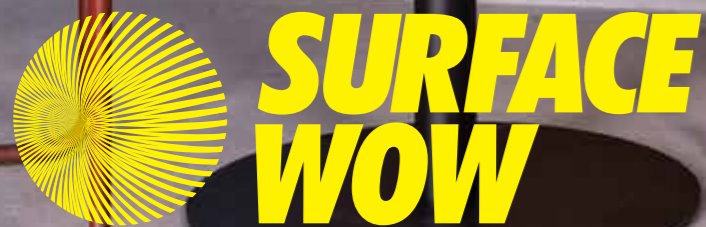





## RUSTICORK / BLUEMOON



RUSTICORK tiles and panels create natural, bold, unique and beautiful walls that only cork, obtained directly from the bark of the cork oak tree, can offer. The cork bark is particularly popular due to its low weight and uncomplicated installation on the wall.

### Description

- Glue-on wall installation
- CORKGUARD® finished
- Safe and easy to handle and install
- Increases the thermal comfort
- Reduces airborne noise
- No toxic gases when burning
- No PVC and no softeners or other chemicals hazardous to health or the environment
- Natural, biodegradable and recyclable product

### Material:

Cork, granulated and plain pieces of different sizes, shapes and qualities depending on the design type; Polyurethane cork binder.

### Dimensions:

600 x 300 mm

### Thickness:

25mm -35mm

### Colours:

Bluemoon

### Design:

3D INSTALLATION

### Application:

Wall design

### Application example:

Anywhere you want to make the interior unique, office walls, hospitality, retail spaces, exhibition stands, reception areas and home.

SURFACE WOW

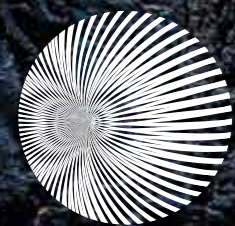

**SURFACE  
WOW**



## RUSTICORK / SLATE



RUSTICORK tiles and panels create natural, bold, unique and beautiful walls that only cork, obtained directly from the bark of the cork oak tree, can offer. The cork bark is particularly popular due to its low weight and uncomplicated installation on the wall.

### Description

- Glue-on wall installation
- CORKGUARD® finished
- Safe and easy to handle and install
- Increases the thermal comfort
- Reduces airborne noise
- No toxic gases when burning
- No PVC and no softeners or other chemicals hazardous to health or the environment
- Natural, biodegradable and recyclable product

### Material:

Cork, granulated and plain pieces of different sizes, shapes and qualities depending on the design type; Polyurethane cork binder.

### Dimensions:

600 x 300 mm

### Thickness:

25mm -35mm

### Colours:

Natural pressed cork bark

### Design:

3D INSTALLATION

### Application:

Wall design

### Application example:

Anywhere you want to make the interior unique, office walls, hospitality, retail spaces, exhibition stands, reception areas and home.

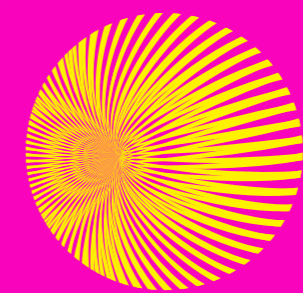
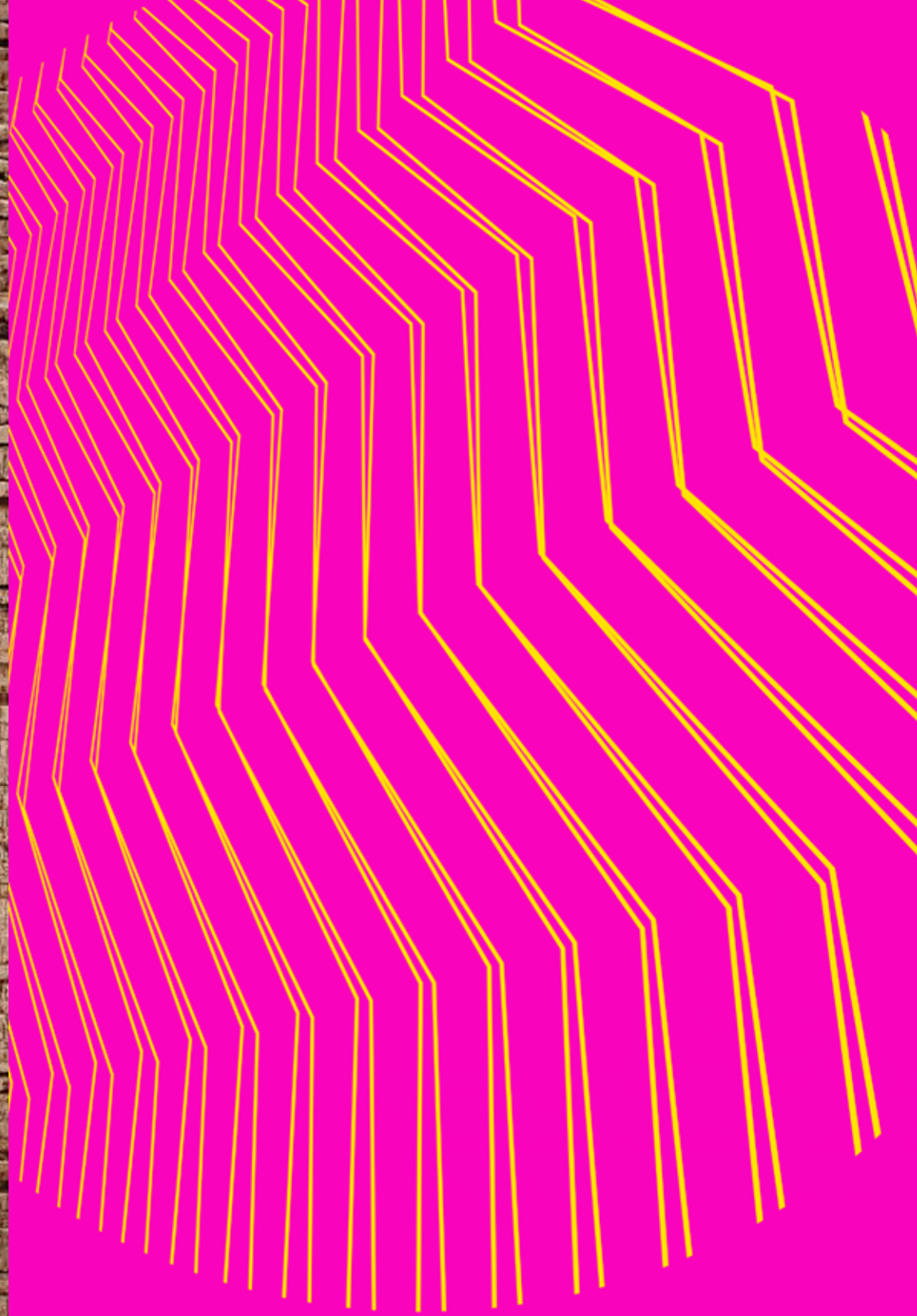

**SURFACE  
WOW**





# 3D FORMS / PYRAMID BLUEMOON

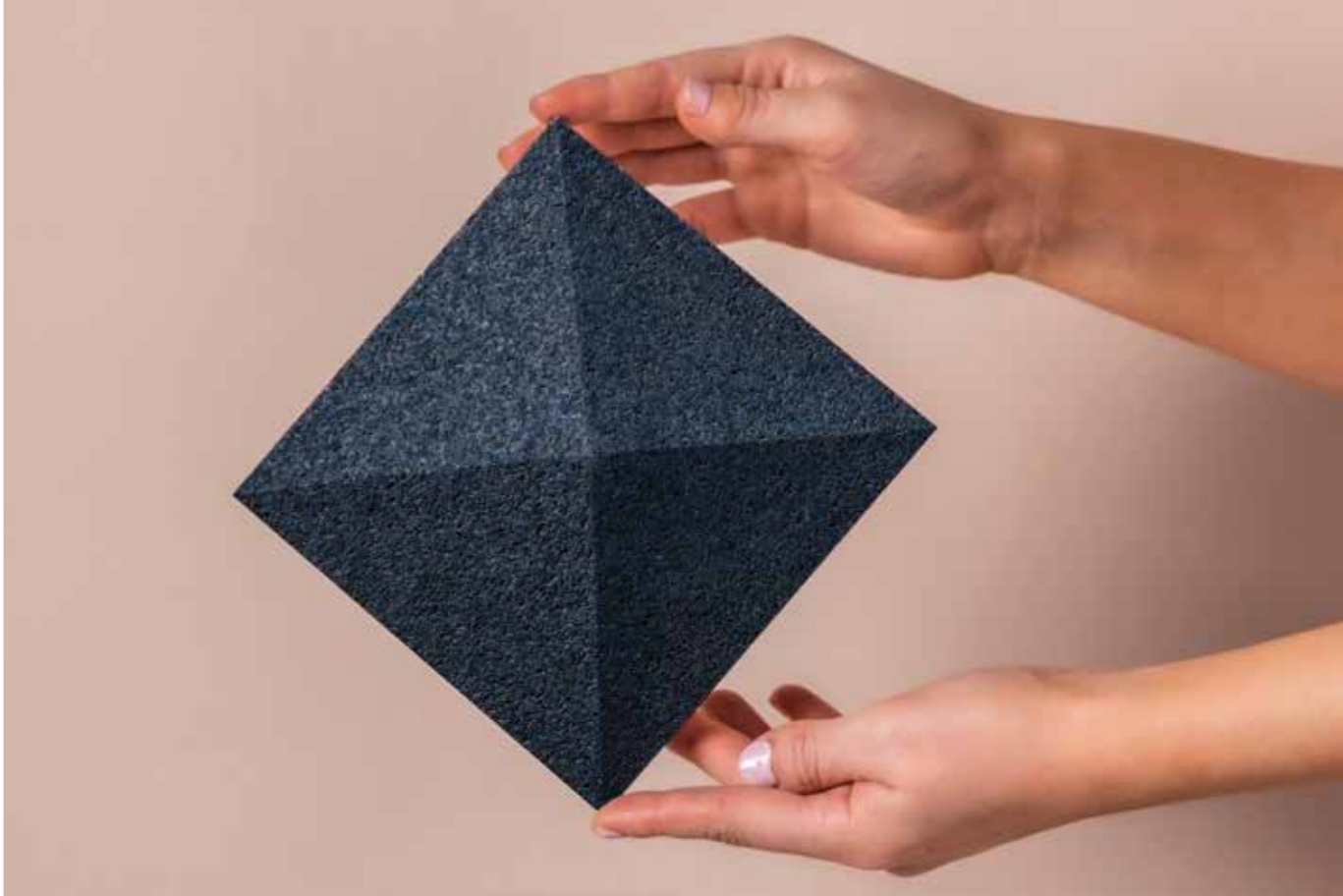

**3D Cork Wall Tiles**

3DFORMS modular cork tiles combine in various arrays to create unique three-dimensional patterns that add depth and identity to vertical surfaces. Delivering an endless amount of creative possibilities, 3DFORMS provides a one-of-a-kind texture with enhanced intrinsic acoustic and thermal properties.

100% post-industrial recycled natural cork  
Glued installation

**CORKGUARD® finished**

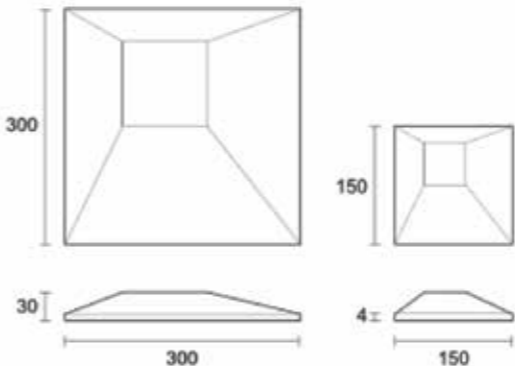

**Dimensions:**

150 x 150 x 30 mm  
300 x 300 x 30 mm

**Colours:**

Blue moon

**Design:**

3D INSTALLATION

**Application:**

Wall design

**Application example:**

Anywhere you want to make the interior unique, office walls, hospitality, retail spaces, exhibition stands, reception areas and home.

**Technical information:**

Thickness: 30mm

**Fire resistance:**

EN ISO 11925-2  
EN 13501-1  
Extent of flame < 150 mm.  
No flaming droplets /particles,  
Fire class E

**Acoustics:** Reduction of airborne noise

WOW WOW WOW

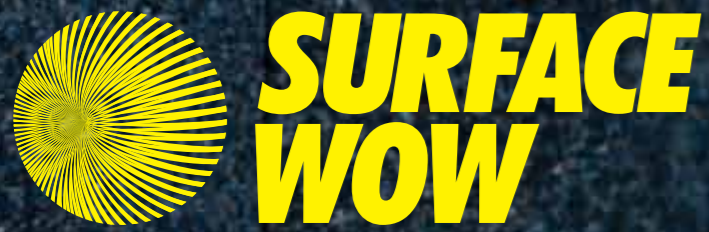

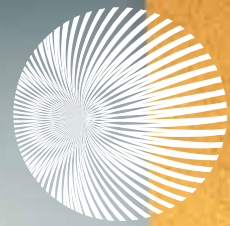

# SURFACE WOW

## 3D FORMS / PYRAMID NATURAL



### 3D Cork Wall Tiles

3DFORMS modular cork tiles combine in various arrays to create unique three-dimensional patterns that add depth and identity to vertical surfaces.

Delivering an endless amount of creative possibilities, 3DFORMS provides a one-of-a-kind texture and enhanced intrinsic acoustic and thermal properties.

100% post-industrial recycled natural cork  
Glued installation

### Material :

Granulated cork 2.0-3.0 mm size and 45/50 Kg/m<sup>3</sup> density. Polyurethane cork binder. CORKGUARD® Aqueous dispersion (clear or coloured).

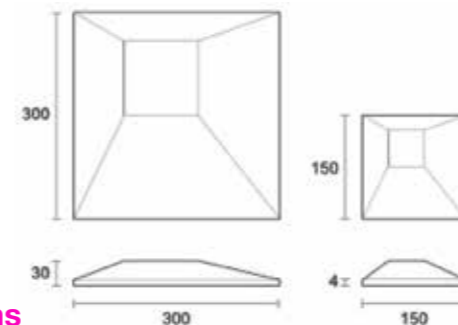

### Dimensions

150 x 150 x 30 mm  
300 x 300 x 30 mm

### Colours:

NATURAL

### Design:

3D INSTALLATION

### Application:

Wall design

### Application example

Anywhere you want to make the interior unique, office walls, hospitality, retail spaces, exhibition stands, reception areas and home.

### Technical information

### Thickness:

30mm

### Fire resistance

EN ISO 11925-2

EN 13501-1

Extent of flame < 150 mm. No flaming

droplets/particles

Fire class E

### Acoustics:

Reduction of airborne noise

### Installation:

Fully bonded with suitable adhesive

### Environment:

3D FORM tiles are made using more than 90% cork, which is a renewable raw material. It contains no PVC and no softeners or other substances hazardous to health or the environment.

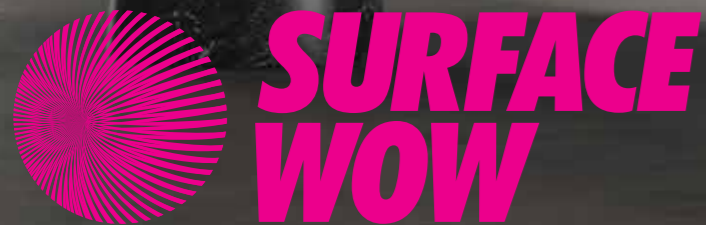

## MODULAR BLUEMOON



Solid agglomerated cork tiles to be used as wallcoverings within buildings, contributing significantly to the acoustic and thermal performance of buildings, improving environmental comfort and reducing energy costs. Tiles are shaped by CNC machining (3 different designs) and finished with a waterbased protector for increased water and stain resistance.

### Material:

100% post-industrial recycled natural cork  
 Glued installation  
 CORKGUARD finished

### Dimensions

580 x 580 x 7 mm

### Colour

BLUEMOON

### Design

3D Installation

### Application

Wall design

### Application example

Anywhere you want to make the interior unique, office walls, hospitality, retail spaces, exhibition stands, reception areas and home. Technical information

### Thickness

7mm

### Fire resistance

EN 13501-1 Fire class E

### Acoustics

Reduction of airborne noise

### Installation

Fully bonded with suitable adhesive

### Environment

3D FORM tiles are made using more than 90% cork, which is a renewable raw material. It contains no PVC and no softeners or other substances hazardous to health or the environment.

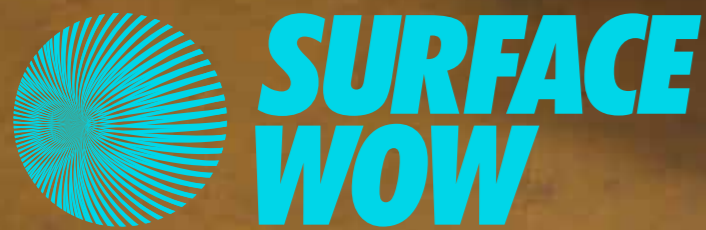

## TATAMI CORK WALL TILES



Solid agglomerated cork tiles to be used as wallcoverings within buildings, contributing significantly to the acoustic and thermal performance of buildings, improving environmental comfort and reducing energy costs. Tiles are textured by pressure moulding and finished with a waterbased protector for increased water and stain resistance.

**Materials:**  
 100% post-industrial recycled natural cork  
 Glued installation  
 CORKGUARD finished

**Dimensions**  
 600 x 300 x 4mm

**Design**  
 3D Installation

**Colour**  
 Natural

**Application**  
 Wall design

**Application example**  
 Anywhere you want to make the interior unique, office walls, hospitality, retail spaces, exhibition stands, reception areas and home. Technical information

**Thickness**  
 4mm

**Fire resistance**  
 EN 13501-1  
 Fire class E

**Acoustics**  
 Reduction of airborne noise ISO 354  
 Weighted sound absorption coefficient  
 $\alpha_w = 0.06$

**Installation**  
 Fully bonded with suitable adhesive

**Environment**  
 3D FORM tiles are made using more than 90% cork, which is a renewable raw material. It contains no PVC and no softeners or other substances hazardous to health or the environment.



# WOW CORKWALL STRIPE



Wow Corkwall Stripe is a collection of environment friendly 3D wall panels made of recycled cork. It is a combination of design, quality, care for the environment and inspired by nature. All panels are made of renewable, recyclable and biodegradable cork material.

Corkwall is a unique 3D wall decoration that completes any interior.

Thanks to their shape, corkwall panels can be arranged in one direction, create symmetrical patterns or create a unique composition. There are countless combinations.

**Dimensions**

**Packs:**  
Panels to make up  
1sq metre: 19

**Weight:**  
230G Natural/  
250g Coloured

**Thickness:**  
13mm

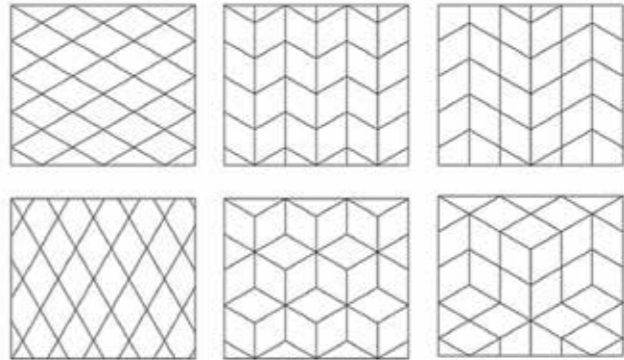
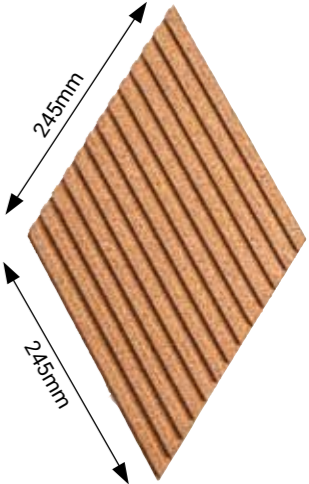

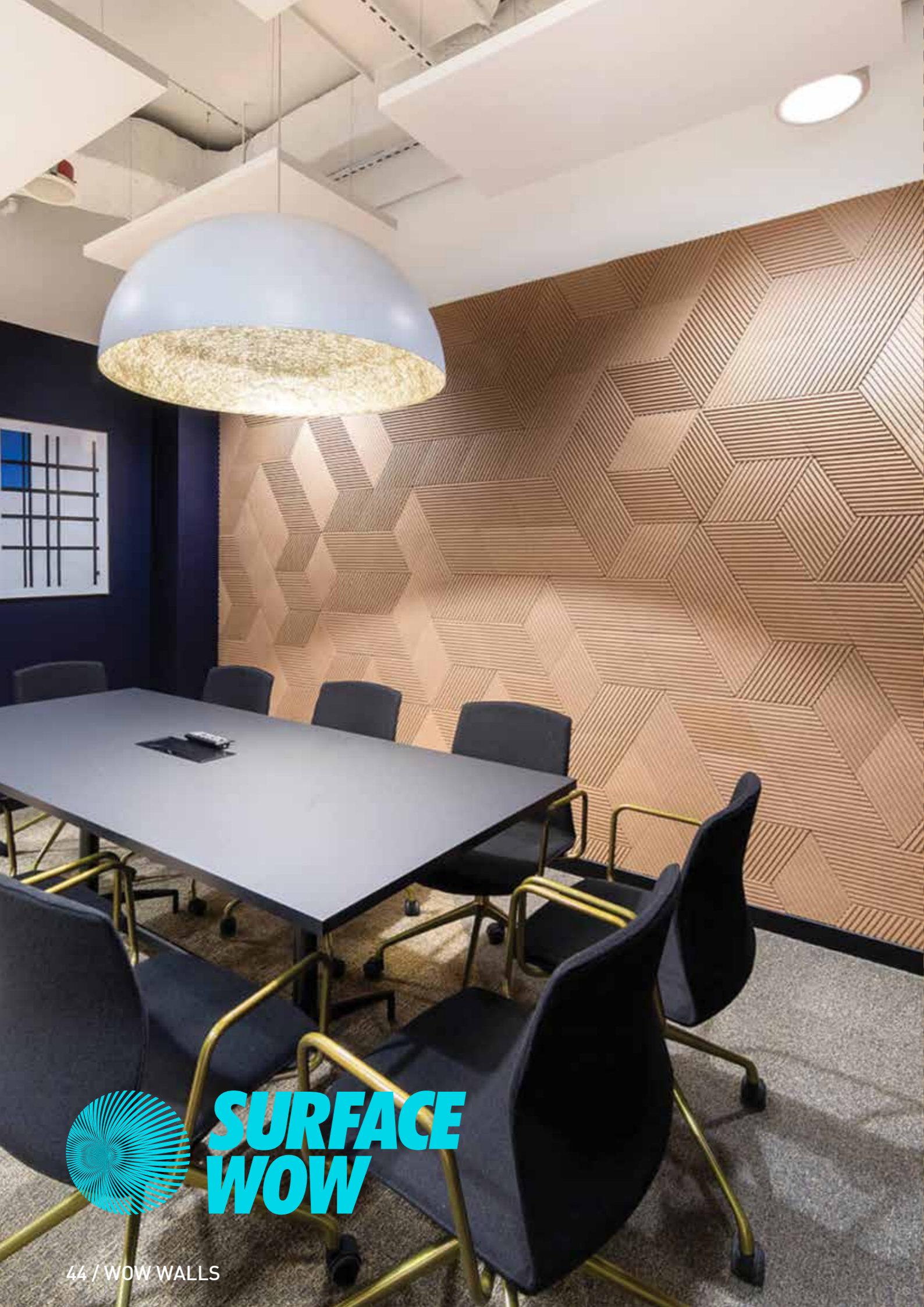

**SURFACE  
WOW**

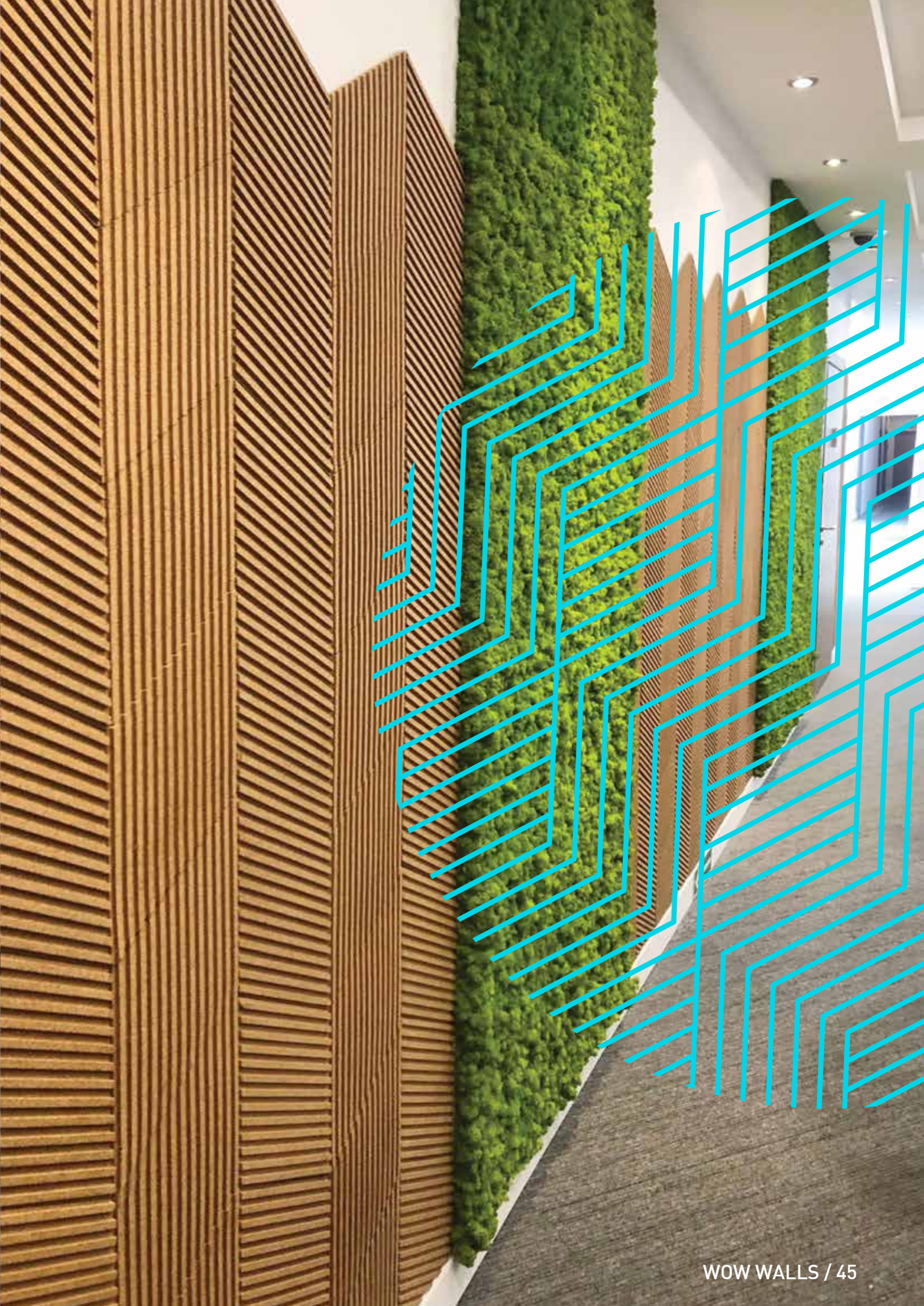

# ***SURFACE WOW***

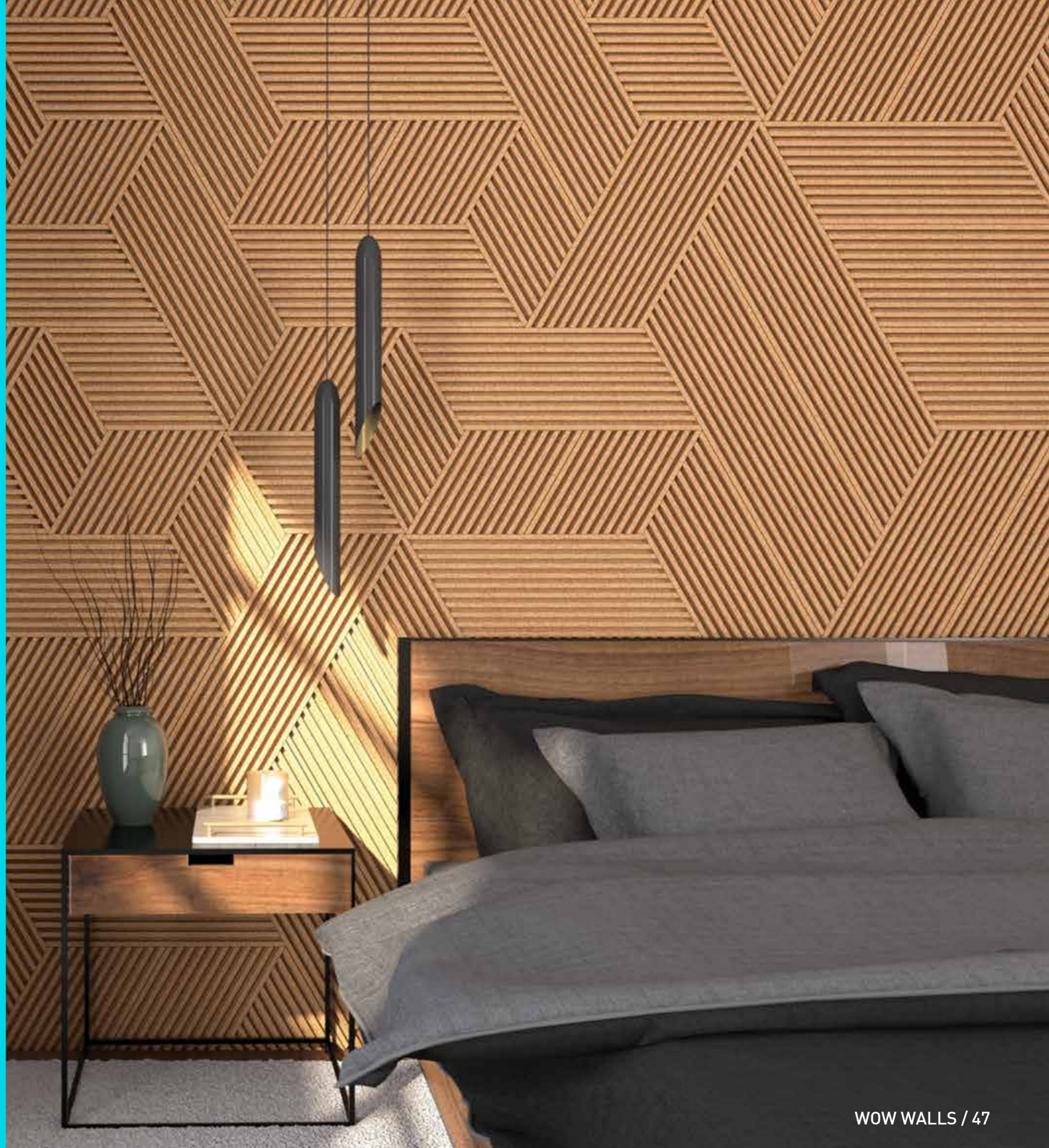
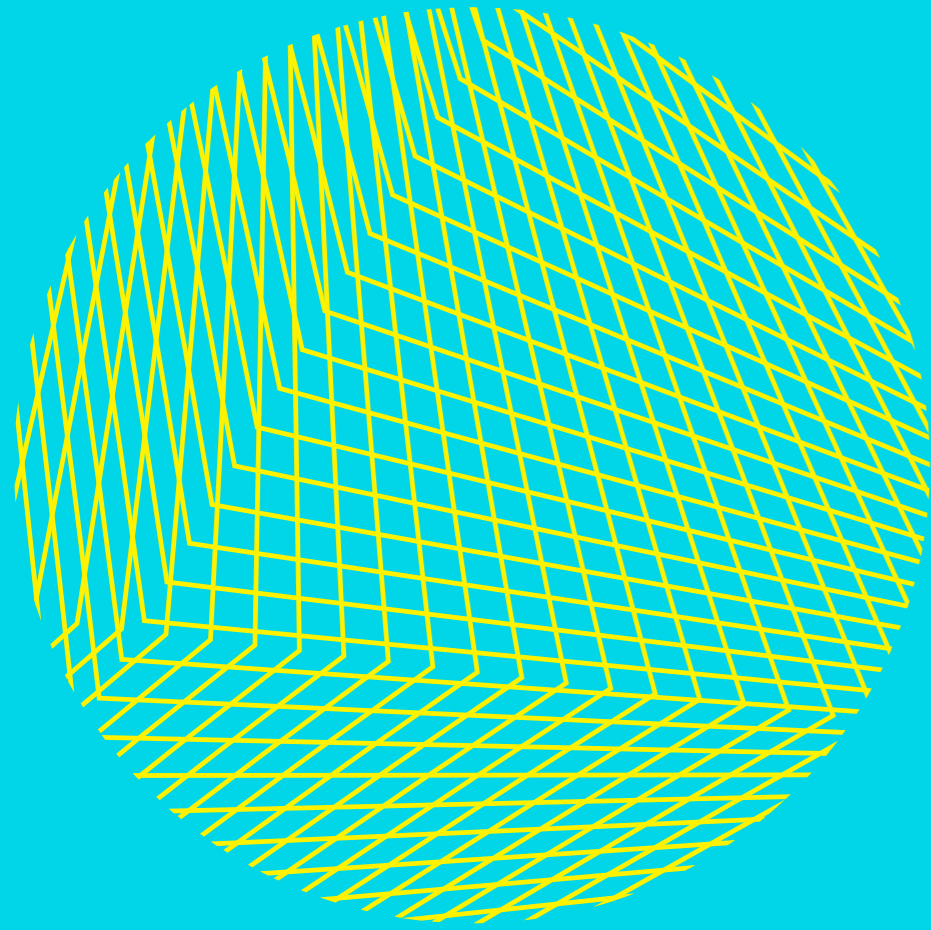





## WOW CORKWALL KITE



Wow Corkwall Kite is a collection of environment friendly 3D wall panels made of recycled cork. It is a combination of design, quality, care for the environment and inspired by nature. All panels are made of renewable, recyclable and biodegradable cork material.

Corkwall is a unique 3D wall decoration that completes any interior. Thanks to their shape, corkwall panels can be arranged in one direction, create symmetrical patterns or create a unique composition.



**There are countless combinations.**

**Panels to make up 1sq metre:**  
40

**Weight:**  
150g Natural/ 180g Coloured

**Thickness:**  
20mm – 30mm

**Dimensions:**

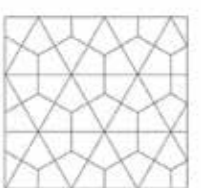
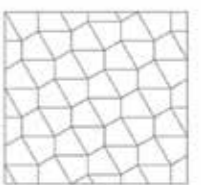
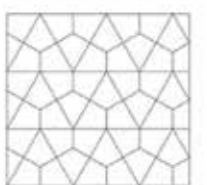
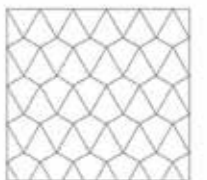
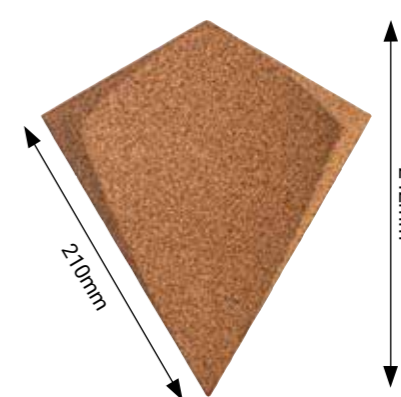

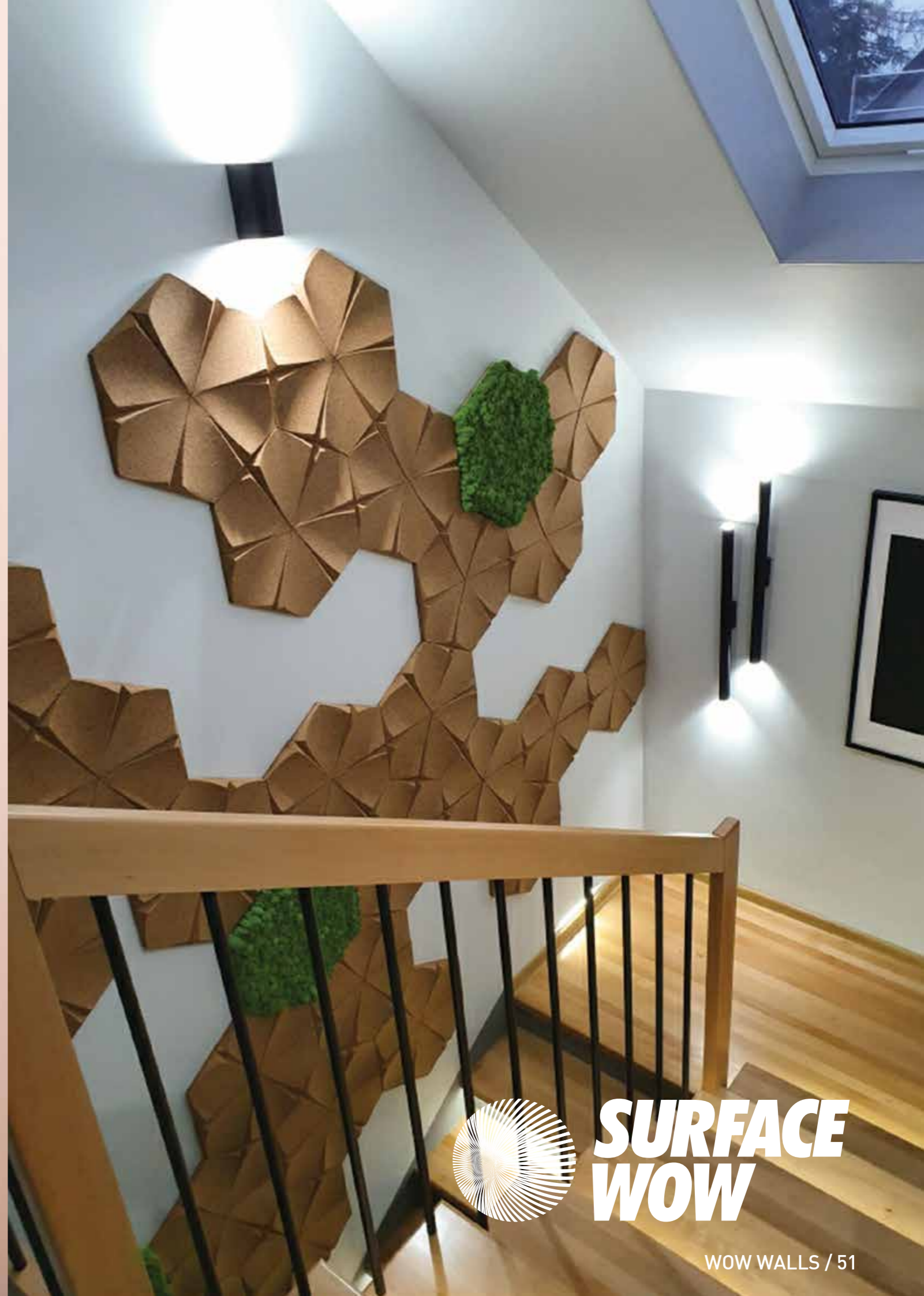

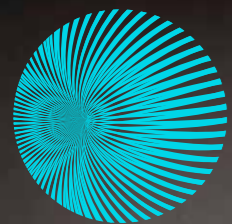

# SURFACE WOW



## WOW CORKWALL LINE



Wow Corkwall Line is a collection of environment friendly 3D wall panels made of recycled cork. It is a combination of design, quality, care for the environment and inspired by nature. All panels are made of renewable, recyclable and biodegradable cork material.

Thanks to their shape, corkwall panels can be arranged in one direction, create symmetrical patterns or create a unique composition.

**There are countless combinations.**

**Panels to make up 1sq metre:**  
19

**Weight:**  
230g Natural/ 250g Coloured

**Thickness:**  
5mm – 30mm

**Dimensions:**

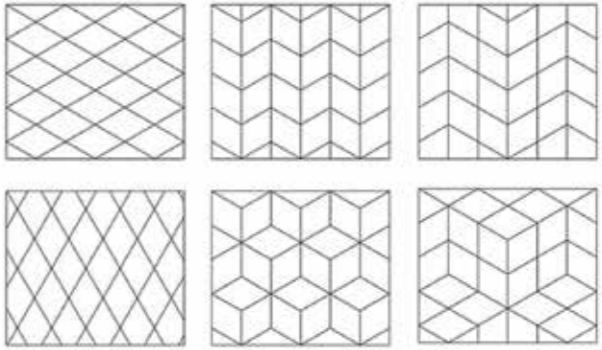
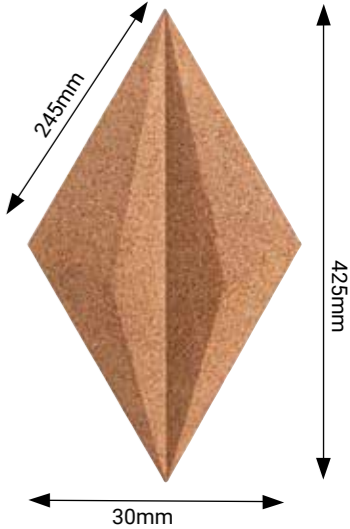

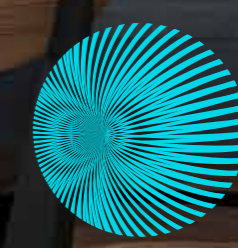

 **SURFACE  
WOW**

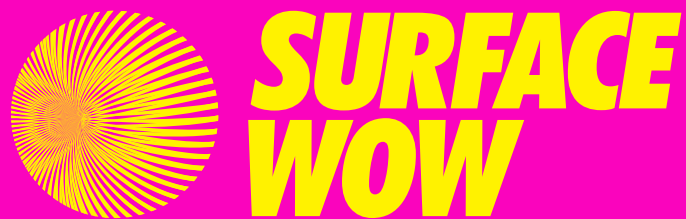

Unit 7 Airton Close,  
Tallaght, D 24,  
Ireland

Tel: +353 1 567 6200  
[info@surfacewow.com](mailto:info@surfacewow.com)

[www.surfacewow.com](http://www.surfacewow.com)